

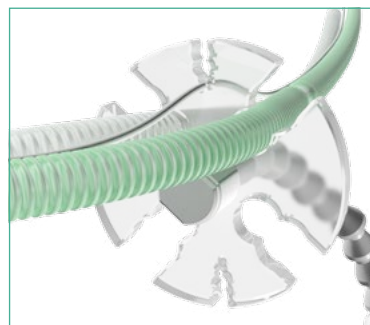

Tube management programme

Help to provide a safe and tidy environment reducing the risk of disconnection and patient trauma.

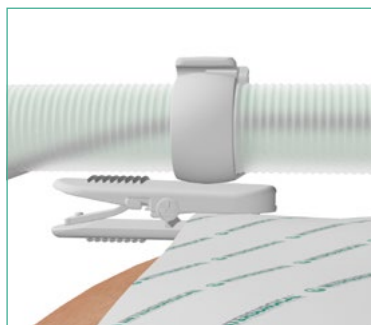

Critical Care ▪ Accessories

Tube management programme

When used in conjunction with Intersurgical breathing systems our full range of tube management options allow the clinician to position our products efficiently and comfortably around the patient area. These help to provide a safe and tidy environment reducing the risk of disconnection and patient trauma.

Intersurgical tube clips, 22F red safety cap and the humidification chamber fill set spike cover are designed to interface with the tube management clip or grip via a notch feature.

Tube clips are available to fit our Smoothbore and Flextube™ breathing systems with options available for 10mm, 15mm, 22mm and 30mm single and dual limb breathing systems.

▶ Video available at www.intersurgical.nl

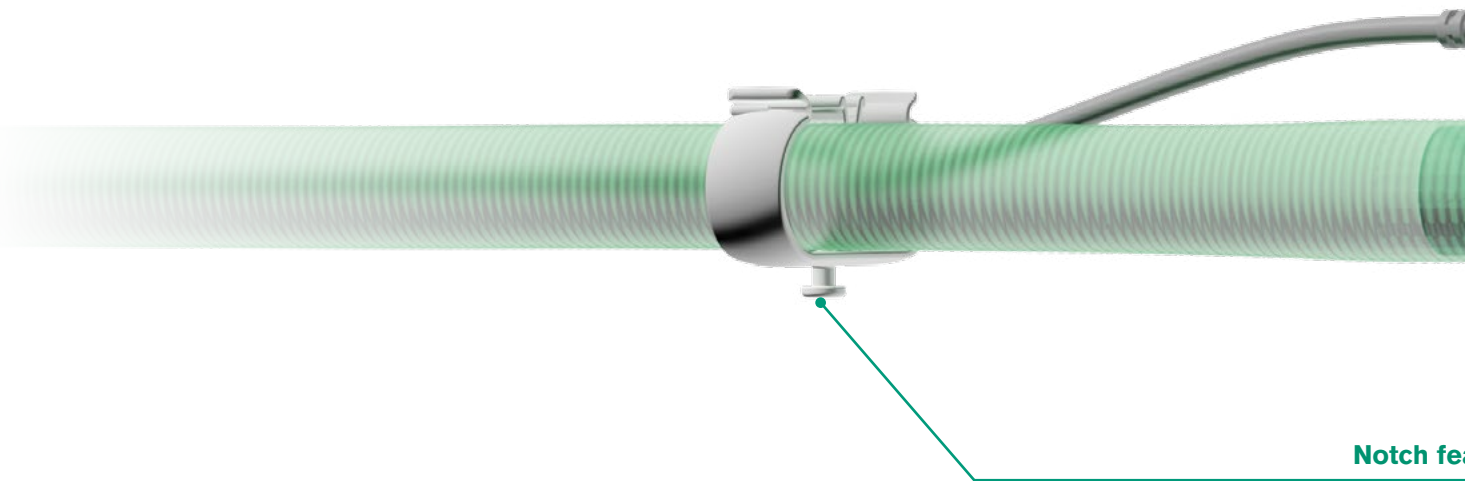

Notch feature

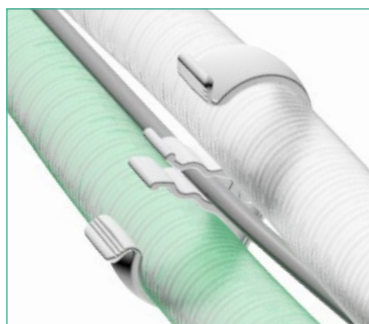

Tube clips 10mm, 15mm, 22mm, 30mm

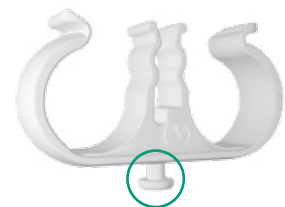

Notch feature

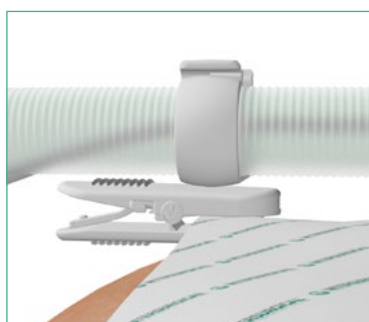

Tube management grip



Tube support

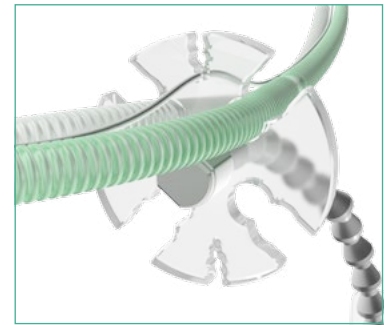
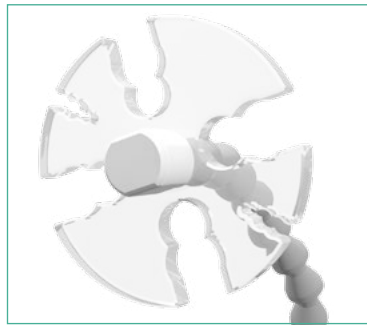
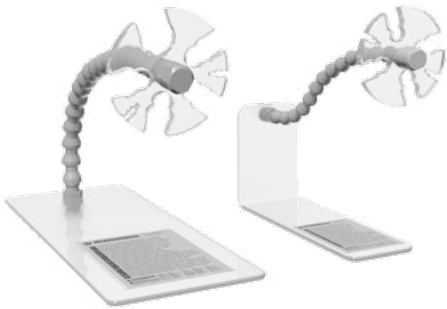

Our ergonomically designed tube support is a neat way of securely holding a breathing system close to the patient. Available in two sizes the tube support efficiently holds in place 10, 15, 22 and 30mm tubes with a smaller groove to grip monitoring lines and cables. The flexible neck is easily positioned to take the strain of the breathing system away from the patient.

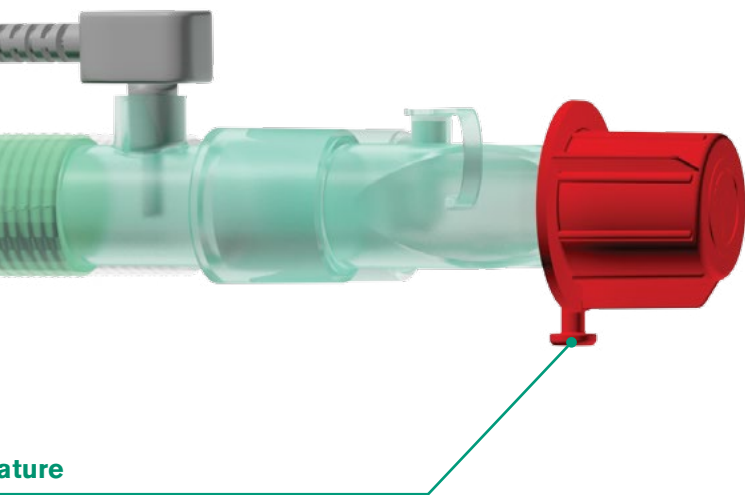

Red safety cap or humidification chamber fill set spike cover



interfaces with



Tube management clip

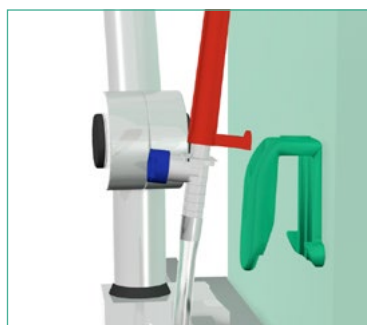

Tube management guide

Flextube™ and Smoothbore tube clip

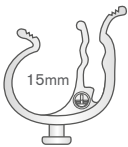

Code	2317000
Box Qty.	25

Flextube tube clip



Code	2315000
Box Qty.	25

Smoothbore tube clip

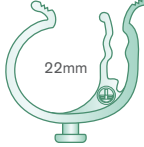

Code	2318000
Box Qty.	25

Flextube tube clip

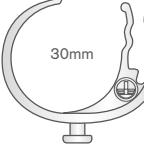

Code	2319000
Box Qty.	25

Flextube and Smoothbore tube clip

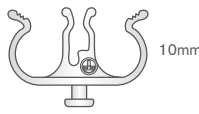

Code	2311000
Box Qty.	25

Flextube and Smoothbore tube clip

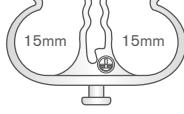

Code	2312000
Box Qty.	25

Flextube tube clip

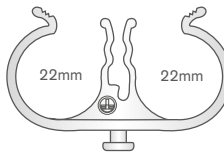

Code	2313000
Box Qty.	25

Smoothbore tube clip

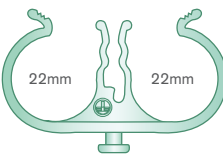

Code	2314000
Box Qty.	25

Tube management clips

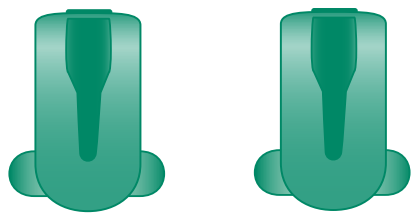

Tube clips



Code	2316000
Box Qty.	12

Tube management grip



Code	2321000
Box Qty.	50

Red safety cap



Safety cap

Code	1978000
Box Qty.	45

Tube support
30mm/
22mm/
15mm

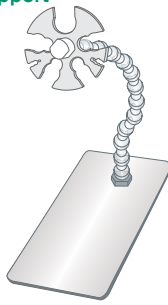

Code	5904000
Box Qty.	1

Tube support
15mm/10mm



Code	5905000
Box Qty.	1

Make an enquiry

IS1.40 NL • Issue 1 06.16



Intersurgical Benelux B.V. Vluchttoord 28, 5406 XP, Uden, Nederland

T: +31 (0)413 243 860 F: +31 (0)413 243 869 info@intersurgical.nl www.intersurgical.nl

UK ▪ Ireland ▪ France ▪ Germany ▪ Spain ▪ Portugal
Italy ▪ Benelux ▪ Sweden ▪ Denmark ▪ Lithuania ▪ Russia
Czech Republic ▪ Turkey ▪ South Africa ▪ China ▪ Japan
Taiwan ▪ Philippines ▪ USA ▪ Canada ▪ Colombia ▪ Australia



Intersurgical Ltd is certified to ISO 14001, ISO 9001 and ISO 13485

Please think before you print
Save energy and paper.
If you must print this e-mail
please print it double sided